

HS-557 Vibration Module

Dual output 4-20mA output

Key Features

- Industrial Accelerometer input
- 4-20mA Velocity or 'g' output
- Low pass filter
- Din Rail Mounted
- Buffered Accelerometer output (for data collection) via BNC and screw terminals
- Temperature Input
- 4-20mA Temperature Output

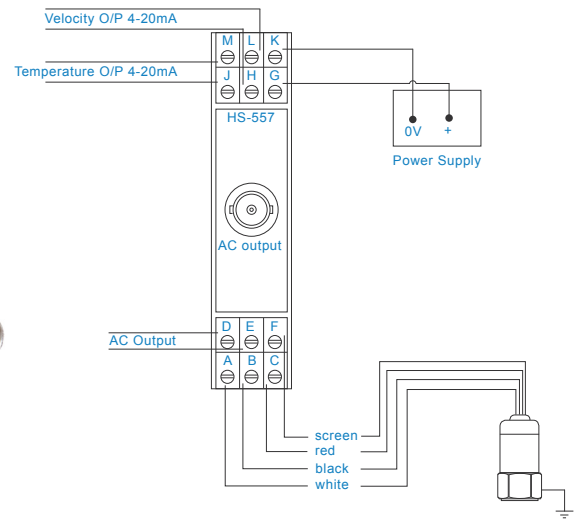

Technical Performance

Input 1	Temperature Sensor PT100 or 10 mV/°C
Acceleration Range or Velocity Range	To be specified
Frequency Range	2 Hz to 10 kHz (-3 dB) - ISO 10816
Filters	Velocity version: 10 Hz to 1 kHz (-3dB) 2-pole Butterworth 'g' version: 10 Hz to 5 kHz (-3dB) 2-pole Butterworth

Mechanical

Case Material	Plastic
Mounting	DIN Rail TS35 (Top Hat)
Dimensions	120 x 75 x 23 mm (HxDxW) including BNC
Connections	Screw Clamp
Conductor Size	0.5 to 4.0 mm
Weight	80 gms (nom)

Electrical

Power Input	24 V DC @ 70 mA (from HS-570 Power Supply Module)
Output 1	Velocity version: 4-20 mA = 0-25 mm/s rms 'g' version: 4-20 mA = 0-5 g rms Max. load resistance = 500 Ohms
Output 2	Temperature 4-20 mA = 0-100 °C (others available)
Output 3	Buffered accel. Output with DC bias voltage (nom 12 VDC) AC only about 0 V on request

Environmental

Operating Temperature Range	0 to 55 °C
EMC	EN61326-1:2013
Installation Category (IEC664)	II
Equipment Class (IEC536)	III

How To Order

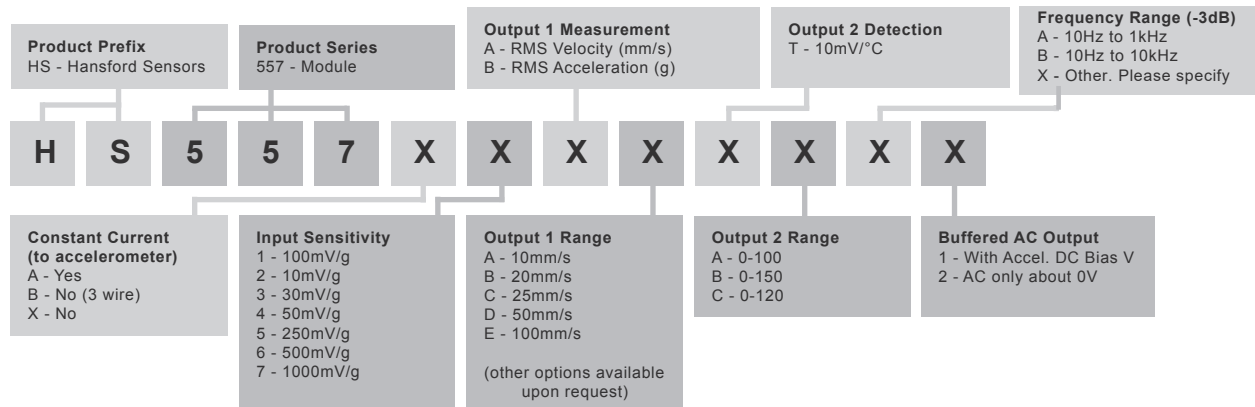

www.hansfordsensors.com
sales@hansfordsensors.com

We reserve the right to alter the specification of this product without prior notice
TS104.8

